

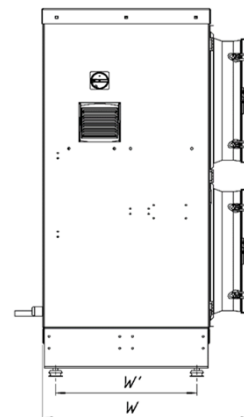

Data sheet

MM2-BK-F45YH

Operating Conditions					
Refrigerant	R449A/R448A				
Ambient Temperature	32				°C
Evaporation Temperature	-30				°C
Subcooling	3				K
Technical Data					
Cooling Capacity	2,21 - 30Hz	3,68 - 50Hz	4,94 - 70Hz	5,45 - 80Hz	kW
Voltage	400/3/50				V/faz/Hz
Nominal power input	1,45 - 30Hz	2,3 - 50Hz	3,03 - 70Hz	3,33 - 80Hz	kW
Max. power input*	5,97				kW
Max. current**	12,5				A
Sound power level	69,17				dB(A) (+/-2dBA)
Sound pressure level	41,17				dB(A), 10m (+/-2dBA)
Compressor Data					
Type	Semi-hermetic Reciprocating				
Number	1				szt.
Nominal power input	1,28 - 30Hz	2,13 - 50Hz	2,86 - 70Hz	3,16 - 80Hz	kW
Max. power input	5,8				kW
Max. current	10,8				A
Starting current	62,2				A
Condenser Data					
Type	Air cooled				
Number of fans	1				szt.
Type of fans	Axial				
Diameter of fans	450				mm
Max. power input***	0,17				kW
Max. current***	1,70				A
Refrigerant receiver					
Type	Vertical				
Volume	14,5				dm ³
Aproximate dimenstions and weight					
Lenght x Width x Height	1800 x 750 x 1410 (L x W x H)				mm
Mounting holes spacing	1660 x 510 (L' x W')				mm
Weight	318				kg
Suction / Liquid line connection	22 / 15				

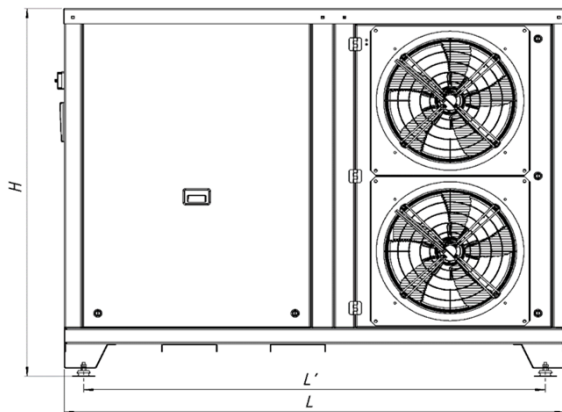

Comments

*Maximum power value is given for compressors and fans.

**Maximum current value is given for compressors and fans.

***Value given for one fan

